



Rev.A Aug.-2022

--	--	--	--	--



Rev.A Aug.-2022

TO-252 P MOS
P-CHANNEL MOSFET in a TO-252 Plastic Package.

AEC-Q101

Low On-Resistance, fast switching, Qualified to AEC-Q101 Standards for High Reliability, HF Product.

DC/DC

Power Management of Industrial DC/DC Converter, Meet the stringent requirements of automotive applications.

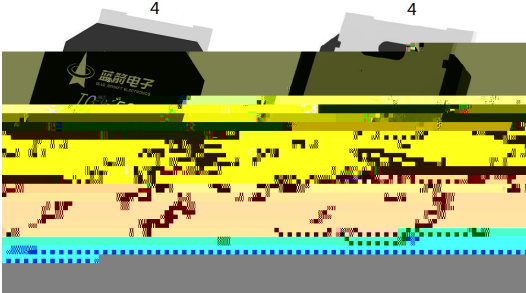

PIN 1 G PIN 2 D PIN 3 S PIN 4 D

See Marking Instructions.



Parameter	Symbol	Rating	Unit
Drain-Source Voltage	V_{DS}	-40	V
Drain Current - Continuous	$I_D(T_c=25^\circ\text{C})$	-50	A
Drain Current – Pulsed	I_{DM}	-128	A



Parameter	Symbol	Test Conditions
-----------	--------	-----------------

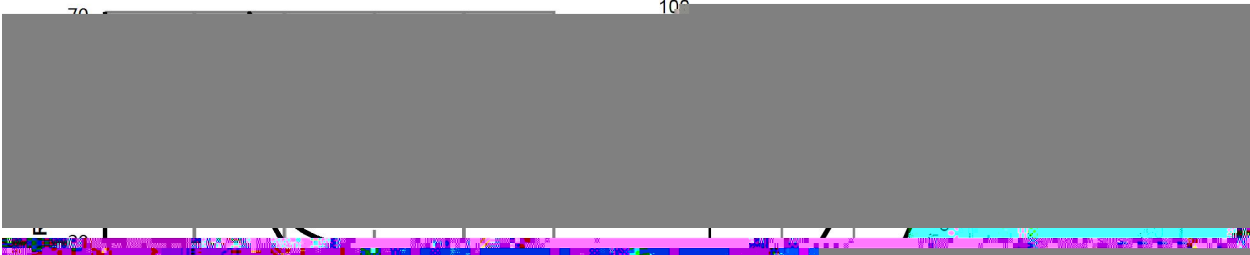
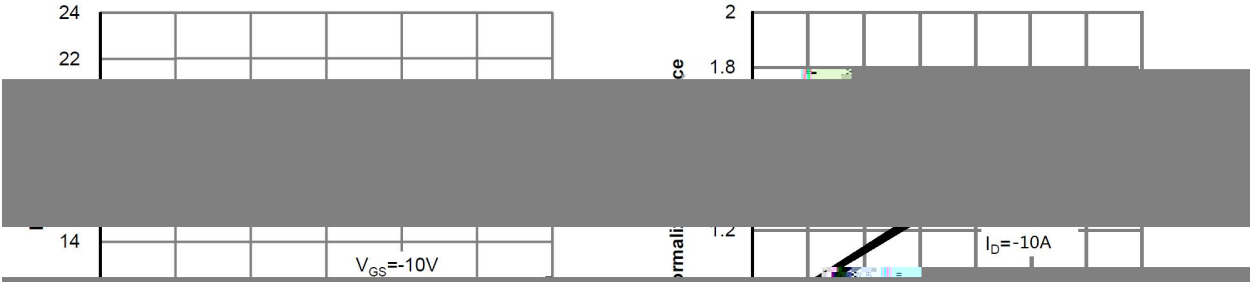
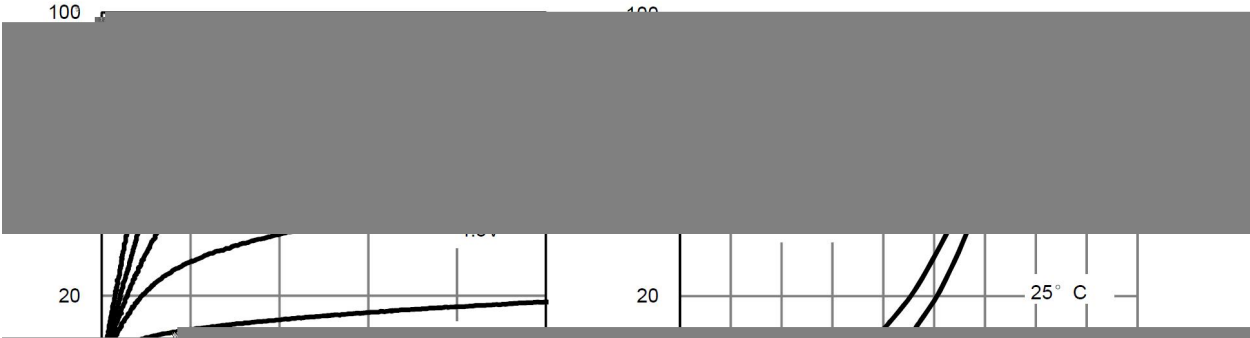

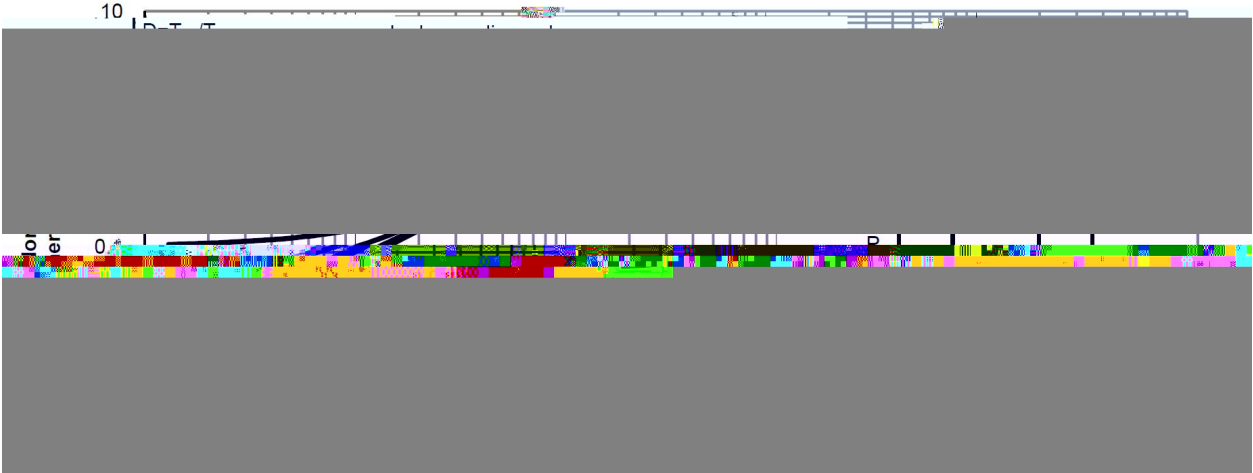
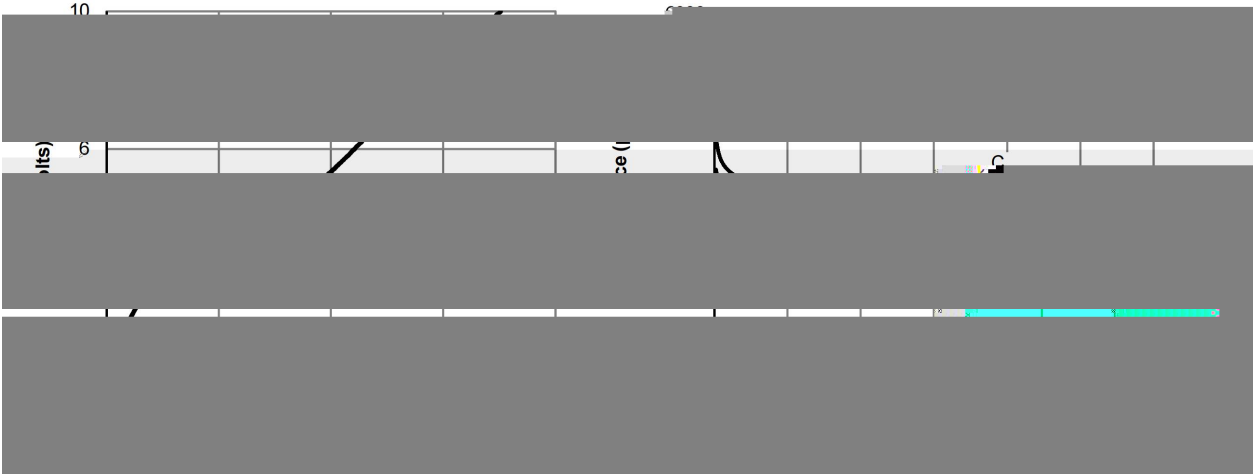
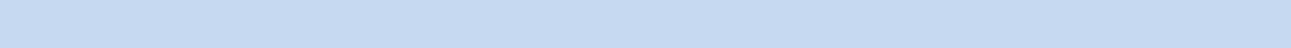

Rev.AA

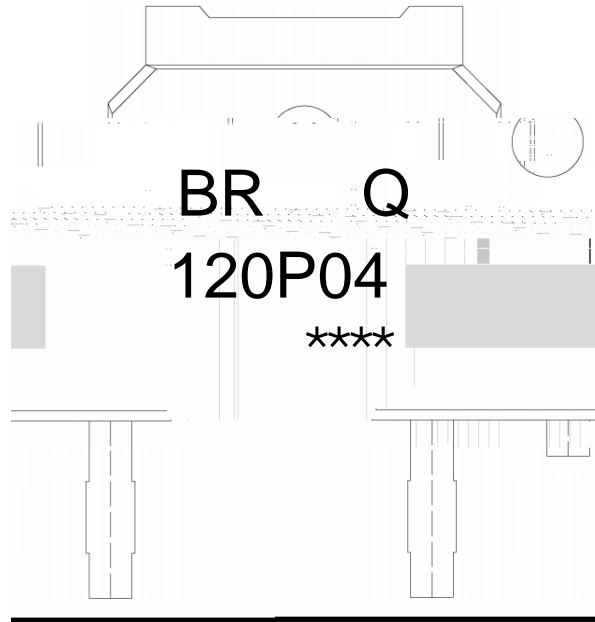

BR

Q

120P04

Note:

BR: Company Code

Q: Automobile halogen-free product Code

120P04: Product Type

****: Lot No. Code, code change with Lot No

