

Parameter

Symbol

/ Electrical Characteristic Curve

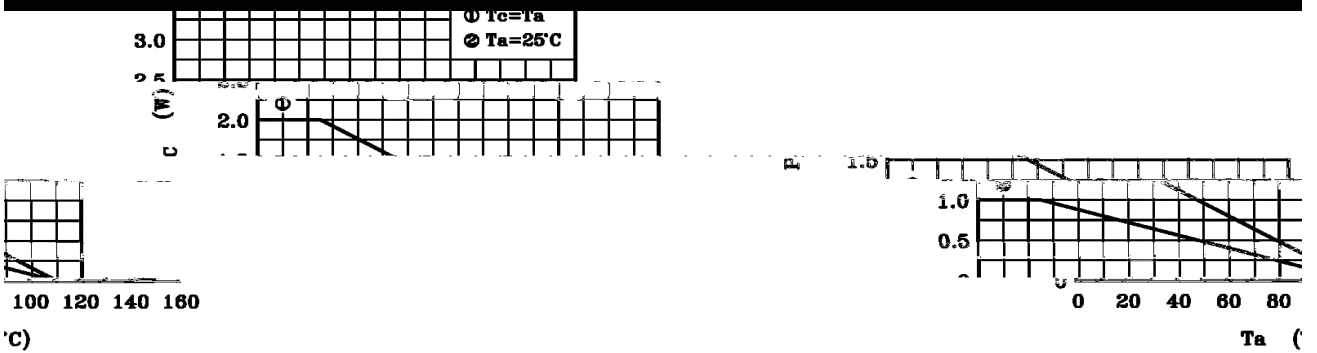
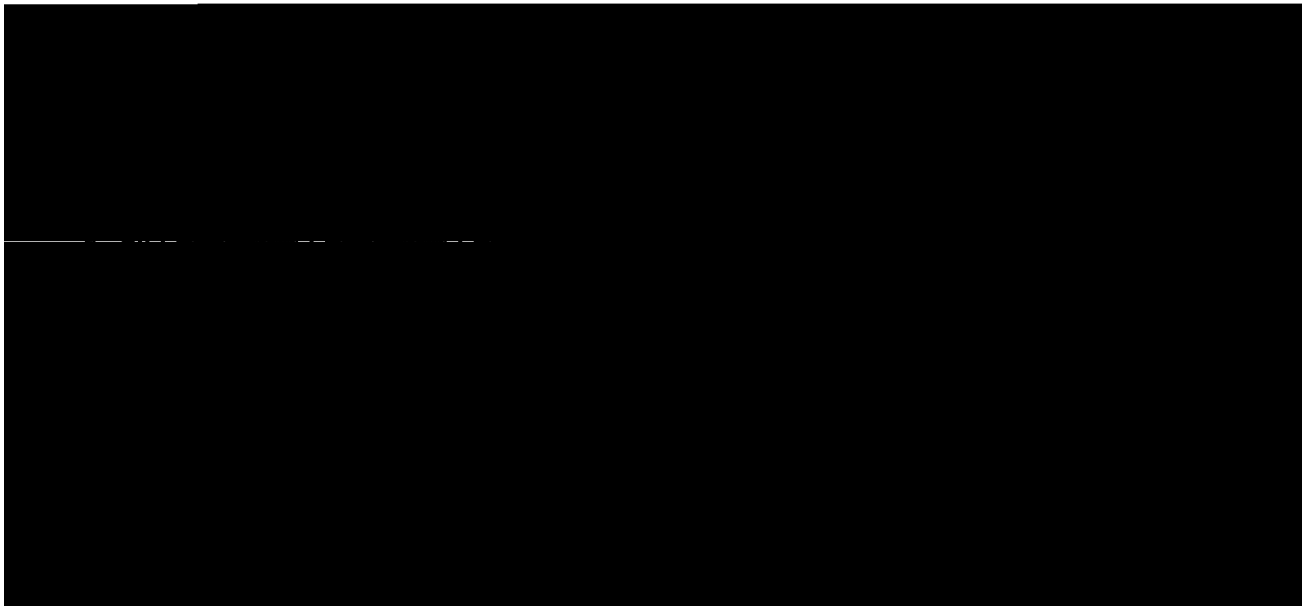
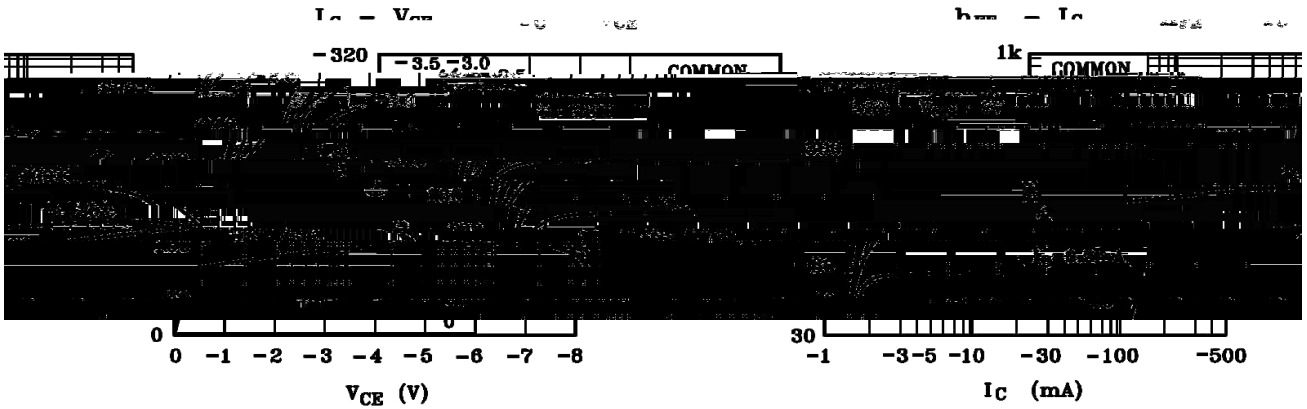

/ Package Dimensions

TO-92LM

Unit: mm

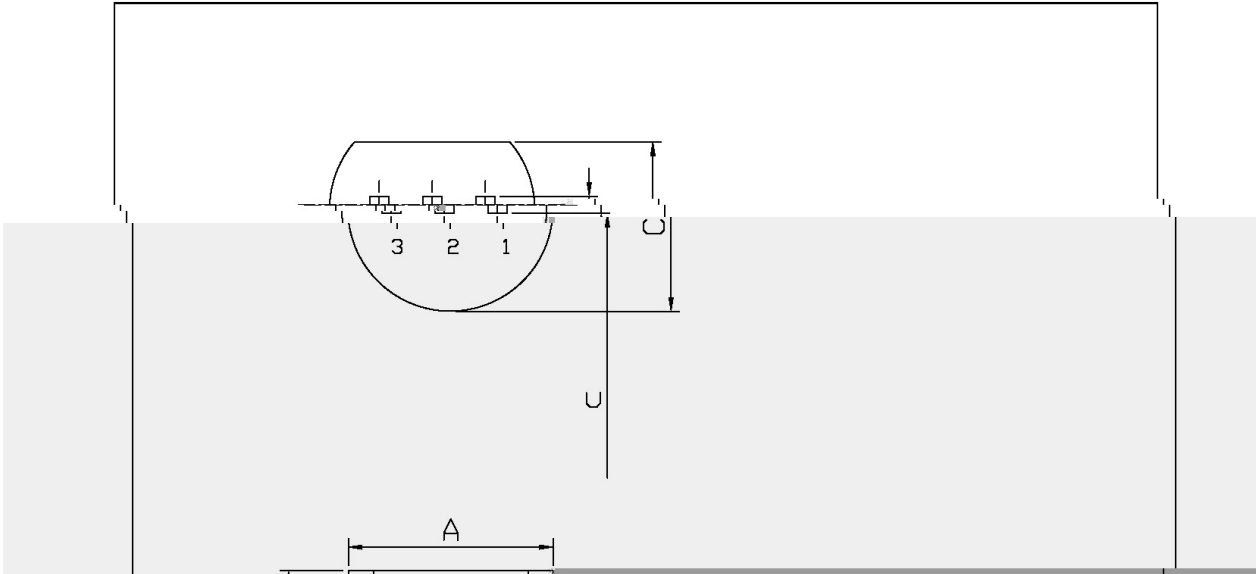

Symbol	Dimensions In Millimeters	
	Min	Max
A	1.27	1.52
U	0.76	1.02

/ Marking Instructions

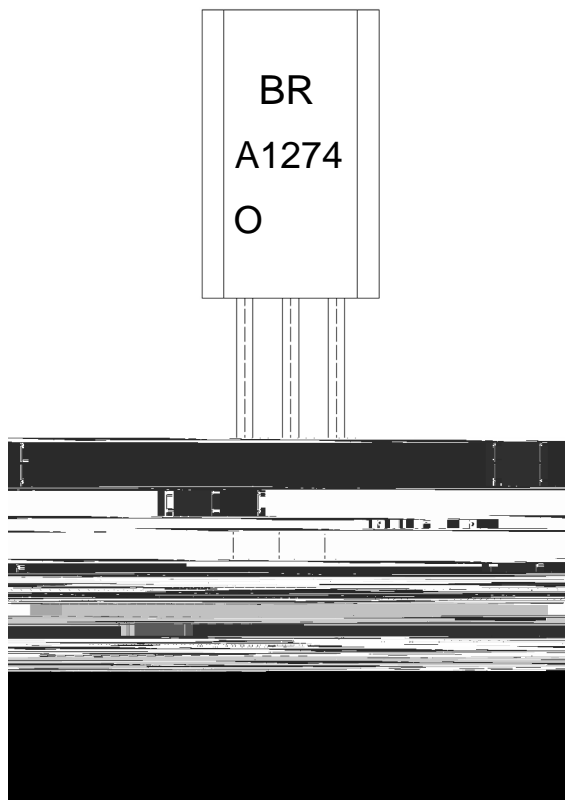

9| 1

8() . +

F 1

!!!!

Note:

BR: Company Code.

A1274: Product Type.

O: h_{FE} Classifications Symbol

****: Lot No. Code,code change with Lot No.

KTA1274