

MBRB20150CT

Rev.G Sep.-2022

/ Descriptions

Schottky Diode in a TO-263 Plastic Package.

/ Features

Low power loss, high efficiency. HF product.

/ Applications

For use in low voltage,high frequency inverters, free wheeling, and polarity protection applications.

/ Equivalent Circuit

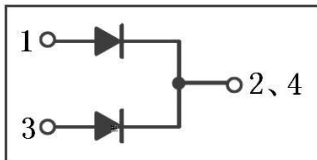

/ Pinning



PIN1 Anode

PIN 2 4 Cathode

PIN 3 Anode

/ hFE Classifications & Marking

See Marking Instructions.

MBRB20150CT

Rev.G Sep

ep@erDehSUS

MBRB20150CT

Rev.G Sep.-2022

/ Package Dimensions

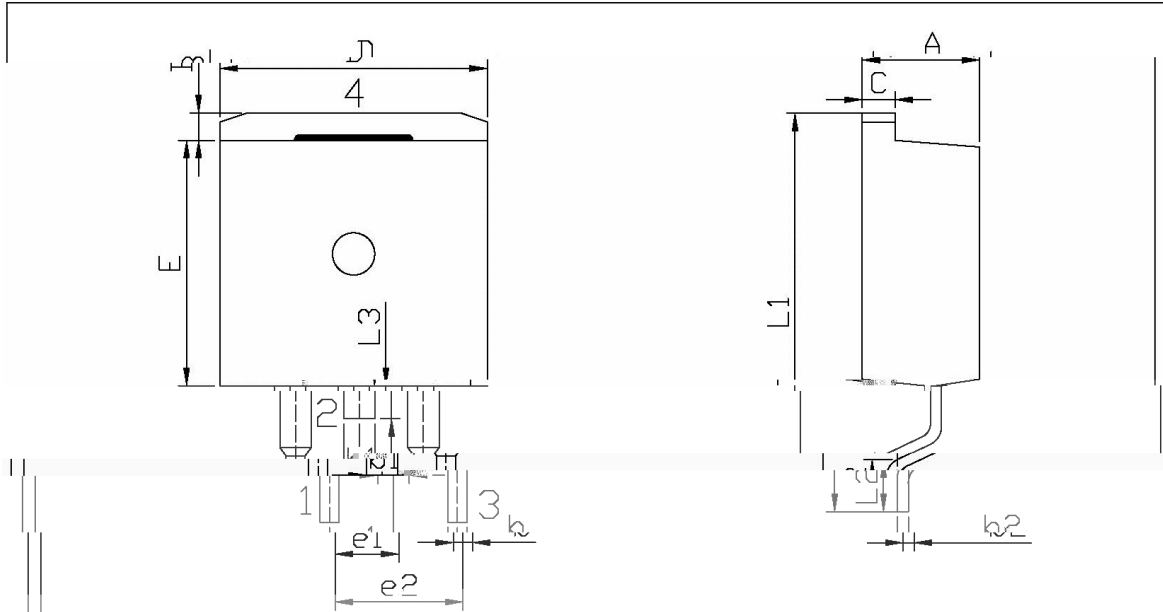

单位: mm

Symbol	Dimensions In Millimeters		Symbol	Dimensions In Millimeters	
	Min	Max		Min	Max
A	4.30	4.70	E	9.00	9.40
R	1.00	1.40	L1	2.25	2.45
L2	0.70	0.90	L3	1.00	1.20
L4	0.50	0.60	L5	0.50	0.60
L6	0.50	0.60	L7	0.50	0.60
L8	0.50	0.60	L9	0.50	0.60
L10	0.50	0.60	L11	0.50	0.60
L12	0.50	0.60	L13	0.50	0.60
L14	0.50	0.60	L15	0.50	0.60
L16	0.50	0.60	L17	0.50	0.60
L18	0.50	0.60	L19	0.50	0.60
L20	0.50	0.60	L21	0.50	0.60
L22	0.50	0.60	L23	0.50	0.60
L24	0.50	0.60	L25	0.50	0.60
L26	0.50	0.60	L27	0.50	0.60
L28	0.50	0.60	L29	0.50	0.60
L30	0.50	0.60	L31	0.50	0.60
L32	0.50	0.60	L33	0.50	0.60
L34	0.50	0.60	L35	0.50	0.60
L36	0.50	0.60	L37	0.50	0.60
L38	0.50	0.60	L39	0.50	0.60
L40	0.50	0.60	L41	0.50	0.60
L42	0.50	0.60	L43	0.50	0.60
L44	0.50	0.60	L45	0.50	0.60
L46	0.50	0.60	L47	0.50	0.60
L48	0.50	0.60	L49	0.50	0.60
L50	0.50	0.60	L51	0.50	0.60
L52	0.50	0.60	L53	0.50	0.60
L54	0.50	0.60	L55	0.50	0.60
L56	0.50	0.60	L57	0.50	0.60
L58	0.50	0.60	L59	0.50	0.60
L60	0.50	0.60	L61	0.50	0.60
L62	0.50	0.60	L63	0.50	0.60
L64	0.50	0.60	L65	0.50	0.60
L66	0.50	0.60	L67	0.50	0.60
L68	0.50	0.60	L69	0.50	0.60
L70	0.50	0.60	L71	0.50	0.60
L72	0.50	0.60	L73	0.50	0.60
L74	0.50	0.60	L75	0.50	0.60
L76	0.50	0.60	L77	0.50	0.60
L78	0.50	0.60	L79	0.50	0.60
L80	0.50	0.60	L81	0.50	0.60
L82	0.50	0.60	L83	0.50	0.60
L84	0.50	0.60	L85	0.50	0.60
L86	0.50	0.60	L87	0.50	0.60
L88	0.50	0.60	L89	0.50	0.60
L90	0.50	0.60	L91	0.50	0.60
L92	0.50	0.60	L93	0.50	0.60
L94	0.50	0.60	L95	0.50	0.60
L96	0.50	0.60	L97	0.50	0.60
L98	0.50	0.60	L99	0.50	0.60
L100	0.50	0.60			



/ Marking Instructions

