

US5AC~US5MC



DATA SHEET

--	--	--	--	--

US5A

\$, - 1 2 3 / Electrical Characteristic Curve

Fig.1 Reverse Recovery Time Characteristic And Test Circuit Diagram

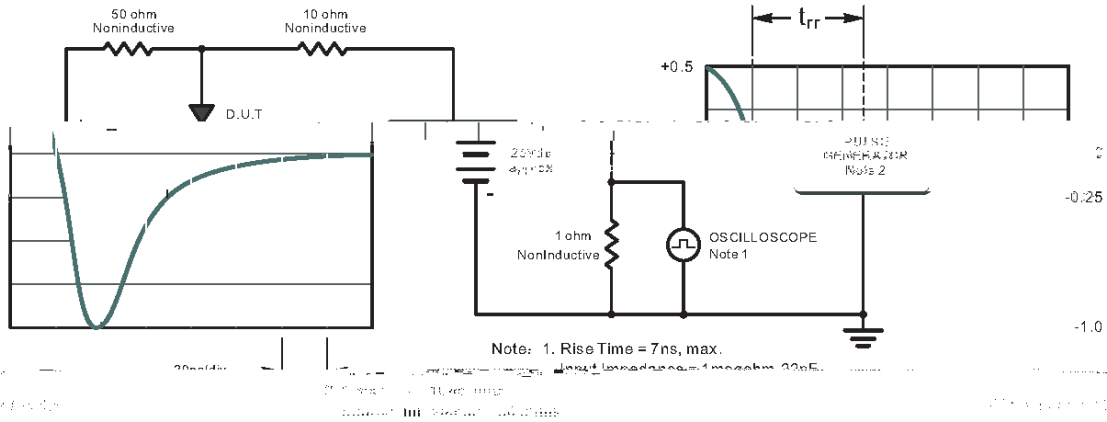

Characteristics

Fig.2 Maximum Average Forward Current Rating

Fig.3 Typical Reverse C

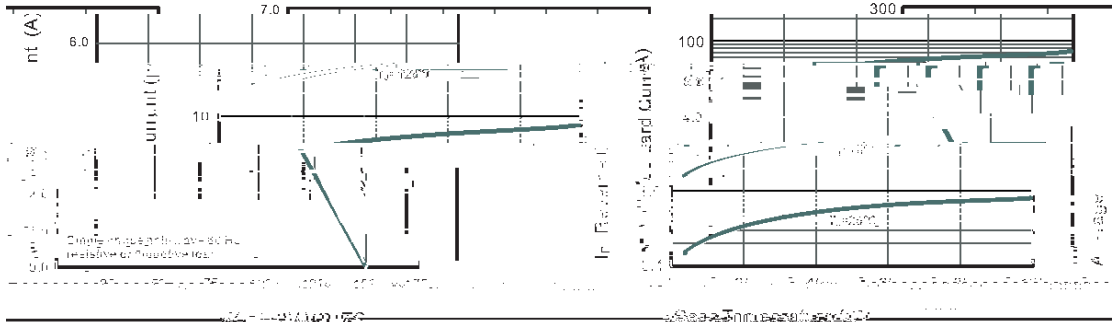
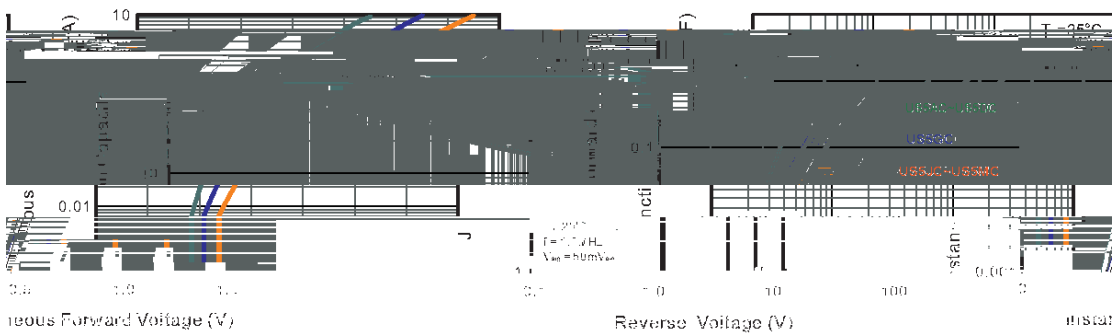

Fig.5 Typical Junction Capacitance

Fig.4 Typical Forward Characteristics



Maximum Non-Repetitive Peak Forward Surge Current

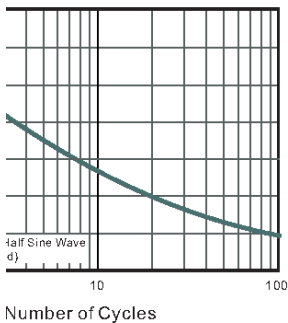
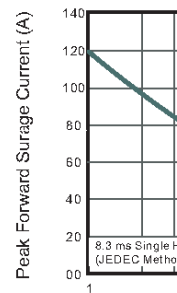
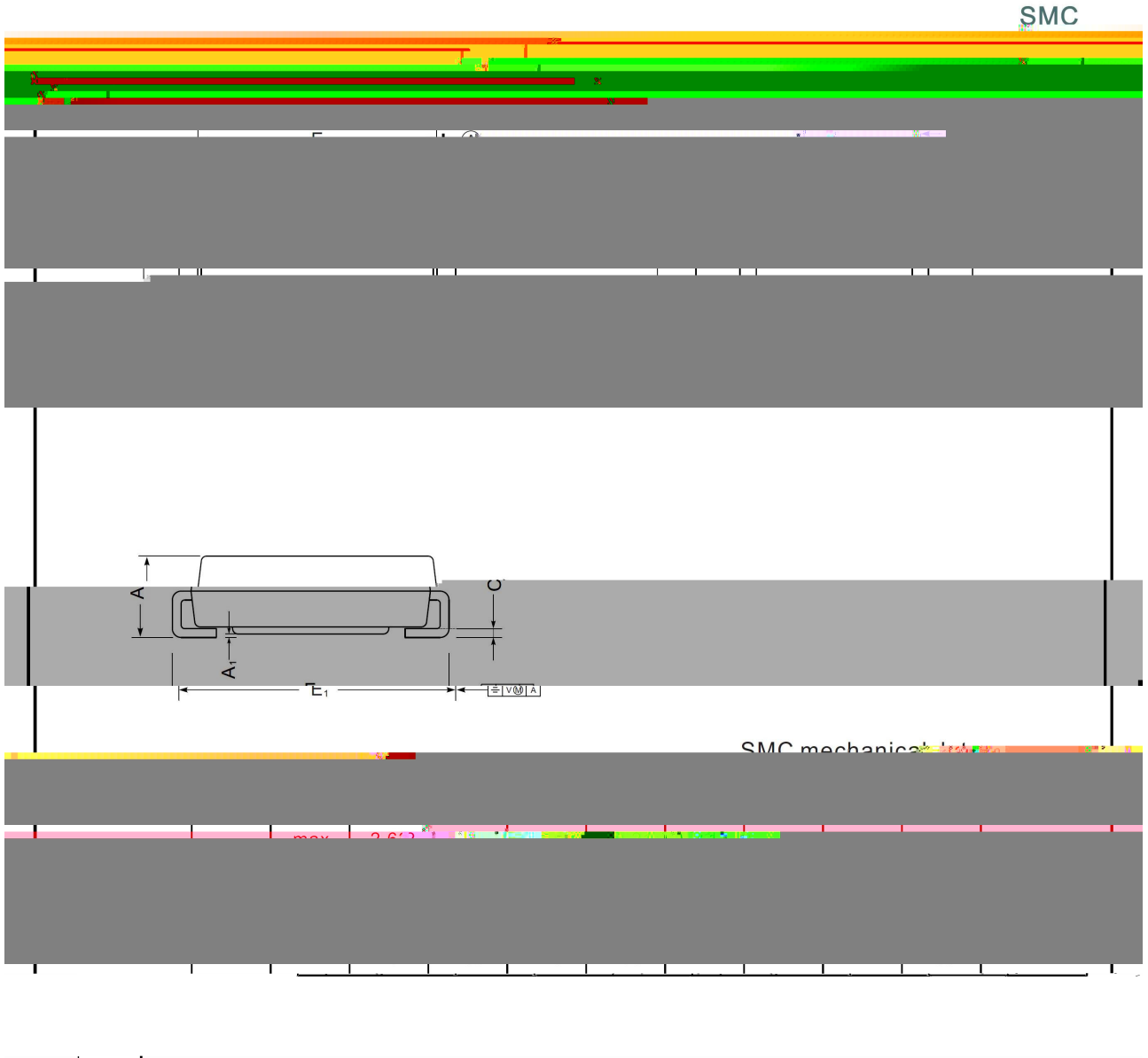

Fig.6 Maximum Forward Surge Current



4 5 6 7 3 / Package Dimensions



Marking

Type number	Marking code
US5AC-100	US5AC-100
US5AC-100	US5AC-100
US5AC-100	US5AC-100
US5AC-100	US5AC-100
US5AC-100	US5AC-100
US5AC-100	US5AC-100
US5AC-100	US5AC-100

89 / Marking Instructions

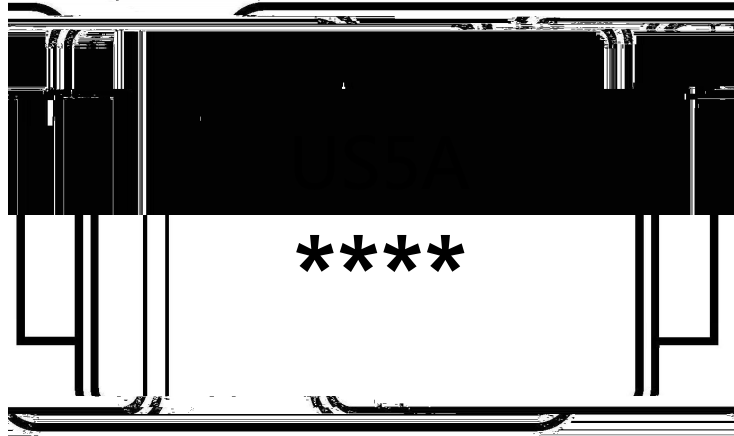

US5A

1 :

3 :

US5A

:

;;

< = > ? @ 1 2 3 (A B) / CDE FGH I J K L M N O P Q R S T U V W X Y Z [\]

